

QUEENSLAND P76  
OWNERS CLUB  
INCORPORATED

P.O. BOX 343  
CARINA 4152

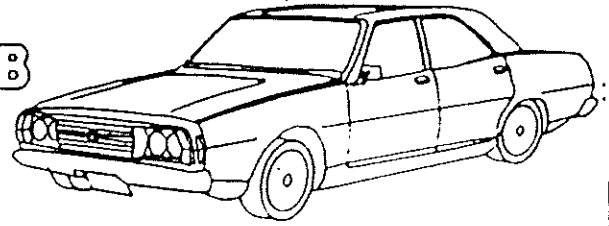

June 1993

200<sup>TH</sup>

ANNIVERSARY

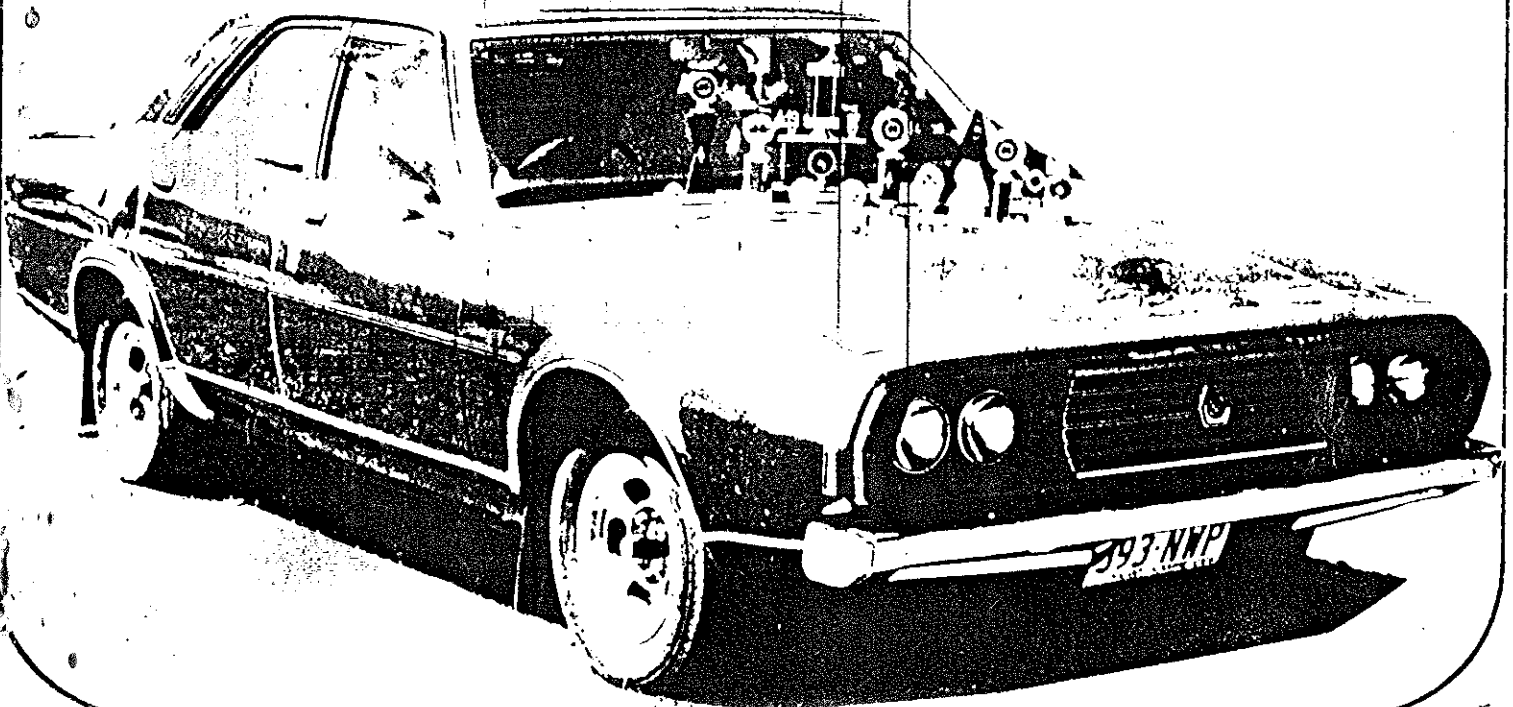

Minutes of meeting held on 9th June 1993

The president opened the meeting at 7 54pm

APOLOGIES;- Peter Rose. Mark Erickson.

Attendance; 10 members. maybe because it was a cold night.

Treasurers Report: Not Available.

Minutes of previous meeting were read by Allan Schutz. and accepted by G, Rogerson and seconded by C. Thompson.

Incoming Correspondence; Magazines from; Canberra/Victoria/Sydney/Westwards/Penzed Association of Motoring Clubs. Letter and Photos from David Morton of the U K.

Paul Thorp wrote to advise of his new address; 87, The Esplanade. Bargara 4670.  
Ph 071 59 2834

Business arising from minutes; EYE CARE. The Vintage Car exhibition being held by the blind association was a non event. Four of our cars turned up ready to set up a display. We were greeted with an empty car park, After locating the caretaker we were informed the event had been cancelled due to lack of support.

Apparently this had been cancelled prior to my enquiries, Someone needs to get their act together.

We then toured around the South Brisbane. west End areas, and finally ended up at Kangaroo Point under the Story Bridge for a picnic lunch.

Swap Meet at Nambour. Enquiries were made with regards to booking sites for camping on Friday night. We were informed no bookings were being taken as

First in best dressed rules apply. It's a good idea to arrive Friday afternoon.

GENERAL BUSINESS A member from the Dept of transport was to be there to discuss modifications to vehicles. However he was in Hospital undergoing Micro Surgery. we wish him a speedy recovery. Haroon has made another date with him as he is still keen to discuss this with our members. The date will possibly be in August you will be advised in the next newsletter.

A vote was taken to have free coffee tea and biscuits each week, Accepted unanimously.

Kon Kelk advised that Thompsons motor spares will only sell parts to Mechanics. Discussion followed on radiators and cooling systems

Dean Hatcher wished to purchase Valley Cover Gasket. These are available at M & R Spares Redcliffe at a reasonable price.

Discussion followed on prevention of cracking to pistons. Sydney covers this fully in their magazine. and those who attended the National Meeting had a demonstration on how this was achieved.

Nominations were called for New Committee.

Meeting closed 9 45 pm

EDITORIAL

This months magazine is a lot fatter, owing to the fact that all the pages are one sided, I found this to be a lot quicker as my Photocopier doesn't seem to like pre- printed paper.

Last meeting positions were called for for the new commottee.

PRESIDENT Haroon Probst. Accepted, Nominated P. Rogerson seconded G, Rogerson.

Haroon has done a good job all year and has attended 90% of all meetings.

Vice President; Neil Lyons, Nominated G. Rogerson seconded H. Probst, accepted by his wife on behalf of neil.

Although Neil has not been able to be present at all the meeting he has always not been been able to step in when required.

Secretary ; Mary Anne Mocker; nominated Pat Rogerson, Seconded Allan Schutz.

This is Mary Anns first time on our committee, but I am Sure she will do a good job with the support of her fiancée Allan Schutz. Congratulations on their engagement

Treasurer, Allan Schutz. Nominated Pat Rogerson seconded Graham Rogerson

Mark Erickson, Nominated Haroon Probst, seconded Gerard Battye.

Allan has done twelve months as secretary for the club ad would like to try his hand at another position. He has attended all meetings and outings,

Mark has been our treasurer for the last twelve months, and although he has done a thorough job, I feel the lack of treasurers reports may be due to other commitments,

A voting form is enclosed for you as members to make the final decision.

Please return to the club in the envelope provided before 14th July 1993 where a secret ballot will ensue.

Editor Pat Rogerson. Nominated H. Probst seconded Allan Schutz. No other

volunteers so you are stuck with me for another year, Bad Grammar and all

Spare Parts Co-ordinator, Graham Rogerson. Nominated Gerard Battye seconded

Allan Schutz. As the shed with all the spares in

it are situated in Grahams back yard, it seems to be the obvious choice, as

Graham attens all meeting its only a phone call to have the parts you require

delivered to the next function.

Voting form for the position of Treasurer

Mark Erickson

Allan Schutz

Place tick in box of candidate of your choice

A.G.M.    A.G.M.    A.G.M.    A G.M.    A.G.M.    .A.G.M.    A.G.M.

Don't forget Wednesday July 14th

Free supper will be supplied by the committee.

Also your subscriptions are now due, so take advantage of the free envelope we have provided, and enclose your cheque, along with the voting form, and your entry for the car Rally.

See you there.

Pat.

-----  
Treasurers Report for February 1993  
-----

Balance as per previous report		2,620.25	
Less: expenses			
Bad Gaskets	(1,104.97)		
Parts	(199.00)		
Parts Shed	(286.00)		
Postages	(32.95)	(1,622.92)	
		-----	
		997.33	
Add: receipts			
Membership subscriptions	60.00		
Sale of Head Gaskets	340.00		
Petty Cash Float - I Ward	100.00		
Misc.	2.80	502.80	
		-----	
		1,500.13	

Reconciliation to Cash at Bank  
(Statement no. 42 - 01/03/93)

Balance as per bank statement	1,190.28	
Less: unrepresented cheques	(138.00)	
Add: deposits in transit	447.85	
	-----	
	1,500.13	

-----  
Treasurers Report for March 1993  
-----

Balance as per previous report		1,500.13	
Less: expenses			
Newsletter	(25.00)		
Hall Donation	(140.00)		
Postages	(181.90)		
Government Tax	(5.40)		
Misc	(15.00)	(367.30)	
		-----	
		1,132.83	

Add: receipts

Membership subscriptions	55.00	
Sale of Head Gaskets	180.00	
Misc.	5.00	
Bank interest	15.24	255.24
		-----
		1,388.07

Reconciliation to Cash at Bank  
(Statement no. 43 - 01/04/93)

Balance as per bank statement	1,286.07	
Less: unrepresented cheques	(138.00)	
Add: deposits in transit	240.00	
	-----	
	1,388.07	

-----  
Treasurers Report for May 1993  
-----

Balance as per previous report		1,388.07	
Less: expenses			
Newsletter	(75.00)		
Post Box Rental	(37.00)		
Postages	(84.80)		
Parts	(489.90)		
Functions	(73.95)		
Misc	(57.00)	(817.65)	
		-----	
		570.42	
Add: receipts			
Sale of Parts	222.00		
Proceeds of Raffle	100.00		
Misc.	60.00	382.00	
		-----	
		952.42	

Reconciliation to Cash at Bank  
(Statement no. 43 - 01/04/93)

Balance as per bank statement	952.77	
Less: unrepresented cheques	(400.00)	
Add: deposits in transit	399.65	
	-----	
	952.42	

SOCIAL CALENDAR

Saturday July 31st

Nambour Swap Meet. at the Nambour show grounds. We will be taking some of the spare parts that we have that don't belong to a P 76. If anyone wants to sell something, bring it along to the swap meet with a price on it. Allan Schutz, Graham and I will be travelling up on Friday night to camp the night. Sunday 1 st August.

The Endeavour foundation are holding a car Rally  
Venue: Centenary Lakes Caboolture, Lots of prizes to be one.  
We have to sign on at 9am for commencement of the rally at 9.30am. So we will meet at the B.P. Burpengary to arrive there in convoy.  
Please return your form to the club Box No with your voting form.

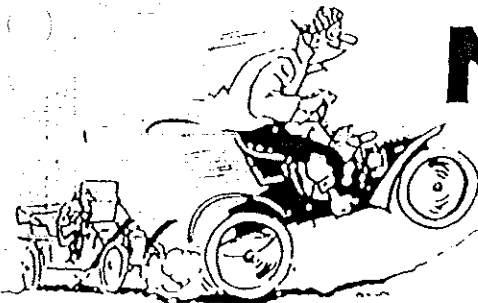

# NAMBOUR SWAP

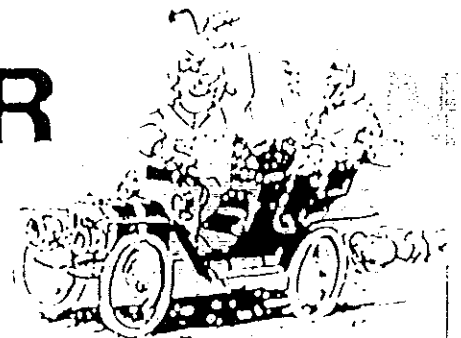

AT THE NAMBOUR SHOWGROUNDS  
SATURDAY JULY 31st 1993

ORGANISED BY THE SUNSHINE COAST ANTIQUE CAR CLUB  
PLENTY OF ROOM OPEN SITES FREE COVERED SITES \$12.00  
HOT FOOD FRIDAY NIGHT NO DOGS ALLOWED  
COME FRIDAY AFTER WORK & CAMP (SMALL CHARGE) - SHOWERS AVAILABLE  
FOOD & DRINKS ON SALE - INCLUDING BREAKFAST FOR THE EARLY BIRDS !  
DISPLAY AREA FOR CARS - BRING YOUR CLUB CAR

THE NEW  
**SPRINGVALE LEYLAND**

**MINI-BITS**  
FOR ALL LEYLAND  
PARTS & SERVICE

NEW & USED SPARES, REPAIRS, DELIVERY,  
LEYLAND, P76, MARINA, AUSTIN, ROVER,  
MG, MORRIS, MINI, MOKE, ALL MODEL TRIUMPHS.

7 BOOLOORA ROAD,  
SPRINGVALE, 3171.



PH: 547 5055 791 6617  
FAX: 546 2208

**ROVER  
AUSTRALIA**  
REGIONAL  
DISTRIBUTOR



Supporting People With Intellectual Disability In The Community

Redcliffe & Northern Districts Branch

# CAR RALLY

Sponsored by Martin Jonkers Motors - Caboolture

## Sunday 1 August 1993

9am - Sign on at Centenary Lakes, Caboolture  
12 noon - (approximately) Presentations  
Rally commencing 9.30 am

Prizes will be given for various categories

Cost: \$10.00 per car

Please fill out the form below  
and send with entry fee to:

Car Rally  
Endeavour Foundation

PO Box 352  
KALLANGUR QLD 4503

Phone: (07) 204 5133

or call Tracey Gordon on (074) 95 5017

**B.Y.O. Picnic  
Lunch**

**Bar-B-Que  
available**

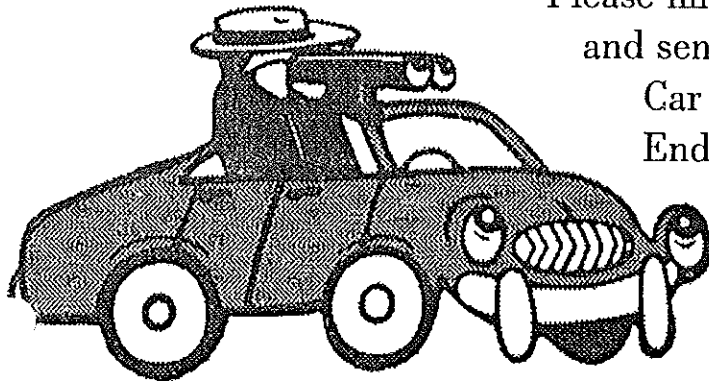

---

# CAR RALLY

Sponsored by Martin Jonkers Motors - Caboolture

Name of Driver: -----

Address: -----  
-----

Phone No: -----

Type of Vehicle: -----

No. of Passengers (no more than two) -----

**\$10.00 ENTRY FEE**

Easter Get Together 1994

Venue; Caboolture caravan park

Plenty of powered and unpowered sites. No Overnight vans

Cabins available. \$30-00 for one person plus \$5-00 each extra person. will accommodate 6 people.

Venue; Sundowner Hotel;

\$40-00 per single room. \$47-00 per double. \$60-00 per triple room.

Family rooms \$75-00

Venue; Caboolture motel

\$49-00 per double room

Self contained family units for 3-4 People \$89-00.

The rates given are current but will be a little higher next Easter.

If you wish to make bookings you can do it direct. Or ring me and I will organise this.

Pat Rogerson 07 888 1345



**CABOOLTURE  
MOTEL**

YOUR HOSTS  
*Carol & Tony Street*

4 LOWER KING STREET  
CABOOLTURE Q 4510

 (074) 95 2888

**CABOOLTURE CARAVAN PARK**  
BRUCE HIGHWAY, CABOOLTURE, QLD. 4510. TEL: (074) 95 1041  
Your Hosts: Kelth and Heather Bates

**WELLER HOTELS**

Sundowner Hotel  
Cnr Caboolture & Bribe Island Rd.  
Aerodrome Drive  
Caboolture. 4506  
Phone (074) 95 8666  
Fax (074) 95 7163

FOR SALE

The Beast as it's affectionally known is being stripped so parts are for sale  
this car was doing low 14s for the quarter mile at Willowbank.

V8 Motor	\$750-00
F.M.X. and Man Shift Kit & Tail Shaft	\$650-00
Adaptor plate	\$200-00
Fuel Pump and Regulator (Holly Blue)	\$150-00
Echlin Heavy Duty Coil	\$ 60-00
2 Slicks & Mags 15 x 10	\$200-00
Diff	\$ 50-00
3 Core Heavy Duty Radiator	\$100-00

Contact M. Dixon 074 95 8601 or G Rogerson 888 1345

CRACKING PISTONS LEYLAND P76 V8 ENGINE

CRACKING PISTONS LEYLAND P76

Cracking pistons have been a constant problem with the Leyland P76 V8 engine. The symptom that usually highlights the problem is a tapping in the engine under load. In many cases it has been known where the skirt on the thrust side drops completely out of the piston.

On investigating the problem an approach was made to Repco (now ACL) who suggested the following modifications.

1. Completely remove the machining register from the inside of the piston skirt. This operation is most important and can be done most successfully with a spur burr in an electric drill.
2. Chamfer the piston skirt edges inside and out.
3. If re-using the original pistons with the tear drop slot. Chamfer the edges of the tear drop.

It can be assumed that cracking commences with the sharp edges, edge cracking. Chamfering the edges reduces the chances of any cracks starting.

It is also advisable to modify new pistons before fitting them into the engine. From all indications so far, carrying out this modification is most successful.

HAPPY & SAFE MOTORING.  
TONY DE LUCA.

CRACKING PISTONS LEYLAND P76

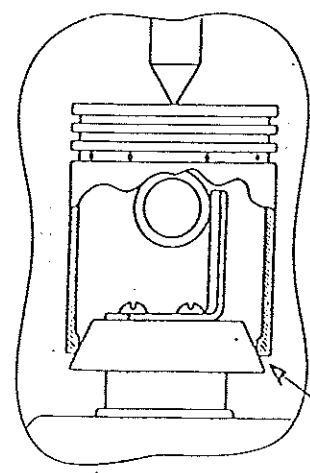

INSIDE REGISTER FOR PISTON MACHINING AND FINISHING

CHAMFER TEAR DROP

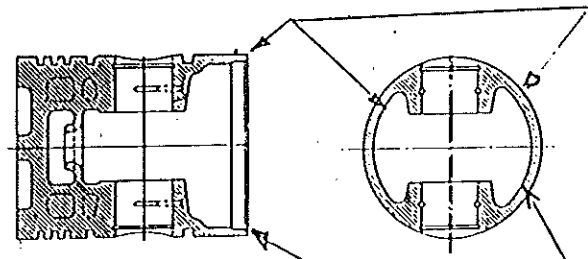
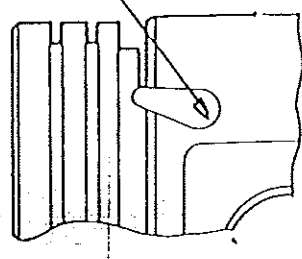

REMOVE REGISTER RIDGE  
(MOST IMPORTANT)

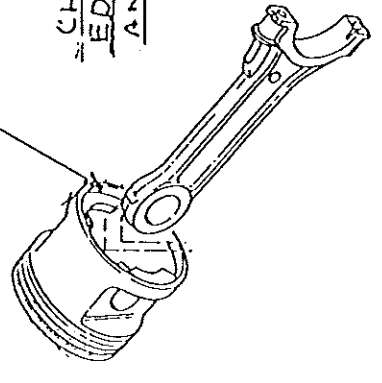

CHAMFER SK  
EDGES INSIDE  
AND OUTSIDE



CLUB INFORMATION PAGE

YOUR COMMITTEE

PRESIDENT

Haroun Probst  
58 Mark Lane  
WATERFORD WEST  
Ph 805 1997 (w) 805 3759 (ah)

VICE PRESIDENT

Neil Lyons  
15, Hall Road  
SPRINGWOOD  
Ph 808 4629

SECRETARY

Allan Schutz  
10, Cooinda st  
EASTERN HEIGHTS  
Ph 202 1054

REASURER

Mark Erickson  
2, Birdvale st  
TARINGA  
Ph 378 6841

EDITOR

Pat Rogerson  
lot 3 Old Gympie rd  
NARANGBA  
Ph 888 1345

SPARE PARTS

Graham Rogerson  
lot 3 Old Gympie Rd  
NARANGBA  
Ph 888 1345

\*\*\*\*\*

This Newsletter is the Official publication of the Queensland P76 Owners Club Incorporated and is issued free of charge to financial members. Any opinions expressed may not necessarily be those of the Editor or the club, and any unintentional defamation or breach of copyright herein is unreservedly apologised for, and a suitable retraction will be inserted in the next edition, once the matter is drawn to our attention.

GENERAL MEETINGS

The Qld P76 owners club Inc holds its monthly meetings on the second wednesday of each month.

TIME 7:30pm

VENUE

Norman Park Uniting Church  
Cnr of Bennetts rd and  
McIlwraith Avenue  
Norman Park  
(At the Round a bout)

\*\*\*\*\*

1993 MEETING DATES

January 13th 93  
February 10th 93  
March 10th 93  
April 14th 93  
May 12th 93  
June 9th 93  
July 14th 93 A.G.M.  
August 11th 93  
September 8th 93  
October 13th 93  
November 10th 93

\*\*\*\*\*

CLUB OUTINGS

Various activities are organised by the clubs members and are generally held on the fourth Sunday of the month. The activity and venue will be advertised in the monthly newsletter.

\*\*\*\*\*

CLUB MEMBER OF THE YEAR

points allocated  
Attend meeting 1 point  
raffle donation 1 point  
organise event 4 points  
attend event 2 points  
win event 1 point